

10G SNR-CVT Series Media Converter User's Manual



Table of Contents

1. 10G SNR-CVT Overview

1.1. General Descriptions of 10G SNR-CVT

10G SNR-CVT series converters is a complete and versatile solution for applications such as FTTx, CWDM, and carrier Ethernet. By the diversified speeds of 1,000Mbps and 10Gbps, SNR provides standalone 10G SNR-CVT for different applications and can be applied according to your ideal network topology.

10G SNR-CVT provides various interfaces such as UTP, SFP, SFP+, XFP and CX4. All these interfaces are developed to support the protocols such as 100Base-Tx, 100Base-Fx, 1000Base-T, 1000Base-X, 10GBase-T, 10GBase-LR, 10GBase-SR and 10GBase-CX4, thus making your network more complete and solid.

All 10G SNR-CVTs are equipped with real-time LEDs which display the status of each port, thus allowing users to view network status easily.

10G SNR-CVT provides an easy-to-access Management Webpage, allowing users to view system status, counters, and network statistics.

Also, 10G SNR-CVT supports MIB Counter Report including counters such as Packet, Byte, Broadcast packet, Pause Frame, Length: 64 Bytes, Length: 65-127 Bytes, Length: 128-255 Bytes, Length: 256-511 Bytes, Length: 512-1023 Bytes, Length: 1024-1518 Bytes, Unicast packet, Multicast packet, CRC Error, IP Checksum Error, Under size packet, and Over size packet.

With various interfaces, 10G SNR-CVT provides different conversions between fibers and copper wires in 10Gbps Ethernet.

1.2. Features, Key Advantages, and Main Applications of 10G SNR-CVT

Features

- Diversified interfaces including SFP, SFP+, RJ45, XFP and CX4
- Supports 3R (Re-generation, Re-timing, Re-shaping) Performance
- Supports Jumbo Frame
- Supports D/D (Digital Detection) functioned optical transceivers and overload protection
- Support easy-to-use Management Webpage that allows users to view system status, counters, and network statistics
- Supports SNMP (Simple Network Management Protocol)
- Supports Link Loss Forwarding

Key Advantages

- Fast connection with multi-function
- Provide reliable long-distance connection
- Port supported: SFP, SFP+, RJ45, XFP and CX4
- Small portable size case
- Plug and play without extra configuration

Main Applications

- Media converter for network backbone
- Connection between fiber to copper or fiber to fiber 10Gbps Ethernet equipment
- Can be applied in Telecommunication room, R&D laboratory, Data center, and etc.

1.3. 10G SNR-CVT Functions Overview

1.3.1. 10G SNR-CVT Outer Case

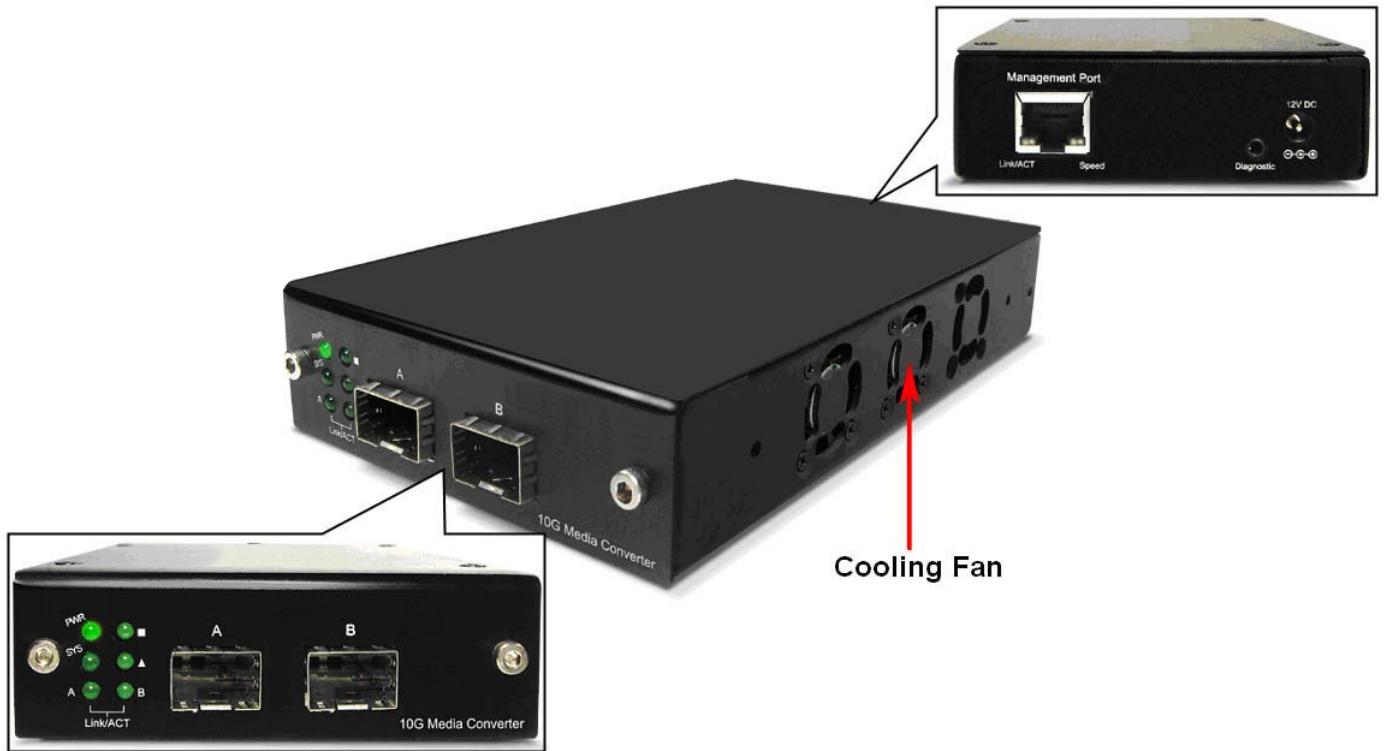

10G SNR-CVT's outer case consists three parts: **Front Panel**, **Cooling Fan**, and **Back Panel**. The figure above shows the outer case of SNR-CVT-XFP. Outer cases of other 10G SNR-CVT are quite the same and can be related.

10G SNR-CVT Outer Case Overview	
Front Panel	10G SNR-CVT comes with various different types of ports, providing media converting platforms for different types of media. Please see “ 1.3.2. 10G SNR-CVT Front Panel ” for more detailed information.
Cooling Fan	Cooling fan for ventilation. All 10G SNR-CVT have cooling fans installed.
Back Panel	10G SNR-CVT's back panels allow users to access their management web pages or making configurations via hyper terminal softwares. Also, 10G SNR-CVT's power jack is located on the back panel as well. Please see “ 1.3.3. 10G SNR-CVT Back Panel ” for more detailed information.

1.3.2. 10G SNR-CVT Front Panel

As mentioned in “1.3.1. 10G SNR-CVT Outer Case”, 10G SNR-CVT comes with various different types of ports, providing media converting platforms for different types of media. Please see the sections down below for more detailed information/specification for 10G SNR-CVT.

A. Front Panel of SNR-CVT-SFP



SNR-CVT-SFP Front Panel Specification		
Interface	Port A	SFP+
	Port B	SFP+
Data Transfer Rate	1000 Mbps	
Ethernet Mode	10GBase-LR	
	10GBase-SR	
LED Status		
Power	Green ON	SNR-CVT-SFP is power on.
	Green OFF	SNR-CVT-SFP is power off.
SYS	Green ON	SNR-CVT-SFP is booting properly and is ready for tests.
	Yellow ON	Error occurred when booting SNR-CVT-SFP.
A/B	Green ON	Port A/B is connected.
	Green Blinking	Port A/B is transmitting/receiving data.
■	User-defined LED	
▲	User-defined LED	

B. Front Panel of SNR-CVT-SFP/XFP



SNR-CVT-SFP/XFP Front Panel Specification		
Interface	Port A	SFP+
	Port B	XFP
Data Transfer Rate	1000 Mbps	
Ethernet Mode	10GBase-LR	
	10GBase-SR	
LED Status		
Power	Green ON	SNR-CVT-SFP/XFP is power on.
	Green OFF	SNR-CVT-SFP/XFP is power off.
SYS	Green ON	SNR-CVT-SFP/XFP is booting properly and is ready for tests.
	Yellow ON	Error occurred when booting SNR-CVT-SFP/XFP.
A/B	Green ON	Port A/B is connected.
	Green Blinking	Port A/B is transmitting/receiving data.
■		User-defined LED
▲		User-defined LED

C. Front Panel of SNR-CVT-SFP/T



SNR-CVT-SFP/T Front Panel Specification		
Interface	Port A	RJ45
	Port B	SFP+
Data Transfer Rate	1000 Mbps	
Ethernet Mode	10GBase-LR 10GBase-SR 10GBase-T	
LED Status		
Power	Green ON	SNR-CVT-SFP/T is power on.
	Green OFF	SNR-CVT-SFP/T is power off.
SYS	Green ON	SNR-CVT-SFP/T is booting properly and is ready for tests.
	Yellow ON	Error occurred when booting SNR-CVT-SFP/T.
A/B	Green ON	Port A/B is connected.
	Green Blinking	Port A/B is transmitting/receiving data.
■		User-defined LED
▲		User-defined LED

D. Front Panel of SNR-CVT-XFP



SNR-CVT-XFP Front Panel Specification		
Interface	Port A	XFP
	Port B	XFP
Data Transfer Rate	1000 Mbps	
Ethernet Mode	10GBase-LR	
	10GBase-SR	
LED Status		
Power	Green ON	SNR-CVT-XFP is power on.
	Green OFF	SNR-CVT-XFP is power off.
SYS	Green ON	SNR-CVT-XFP is booting properly and is ready for tests.
	Yellow ON	Error occurred when booting SNR-CVT-XFP.
A/B	Green ON	Port A/B is connected.
	Green Blinking	Port A/B is transmitting/receiving data.
■	User-defined LED	
▲	User-defined LED	

1.3.3. 10G SNR-CVT Back Panel



10G SNR-CVT Back Panel Description		
A	Management Port	100 Mbps RJ45 Management Port for connecting 10G SNR-CVT series to a network, thus allowing users to access 10G SNR-CVT's management web pages
B	Diagnostic Port	2.5mm Phone Jack for connecting PC's RS 232 port, thus allowing users to make configurations via hyper terminal softwares.
C	Power Jack	DC 12 V Power Jack

2. 10G SNR-CVT Series Installation

As a media convertor platform, installing 10G SNR-CVT series is very easy and simple: all you have to do is to plug the proper fiber/UTP cables into 10G SNR-CVT series' ports like a general Ethernet switch without any extra configurations. However, selecting the proper physical media and applications in your network environment is crucial when installing 10G SNR-CVT series. Please see the sections down below for detailed information regarding to physical media types and 10G SNR-CVT series application.

2.1. Choices of UTP Cable and Optical fiber

2.1.1. 10GBASE-T (Copper Wire)

10GBASE-T, or IEEE 802.3an-2006, is a standard released in 2006 to provide 10 gigabit/second connections over unshielded or shielded twisted pair cables and over distances up to 100 meters (330 ft). 10GBASE-T cable infrastructure can also be used for 1000BASE-T, allowing a gradual upgrade from 1000BASE-T, and auto-negotiation to select which speed to use.

10GBASE-T Connectors

10GBASE-T uses 650 MHz versions of the venerable IEC 60603-7 8P8C (RJ-45) connectors, which is already widely used in Ethernet.

10GBASE-T Cables

10GBASE-T works up to 55 m (180 ft) with existing Category 6 cabling. In order to allow deployment at the usual 100 m (330 ft), the standard uses a new partitioned Category 6a cable specification, designed to reduce crosstalk between UTP cables.

The table down below is a reference regarding to UTP cable categories.

UTP Cable Categories References	
Cat 5	Provides performance of up to 100 MHz, and was frequently used on 100 Mbps Ethernet networks. Cat 5 may not be suitable for 1000BASE-T gigabit Ethernet.
Cat 5e	Provides performance of up to 100 MHz, and is frequently used for both 100 Mbps and Gigabit Ethernet networks.
Cat 6	Provides performance of up to 250 MHz, more than double of category 5 and 5e. It works up to 55 m (180 ft) for 10Gbps Ethernet.
Cat 6a	Provides performance of up to 500 MHz. It is suitable for 10GBASE-T and works up to 100 m (330 ft) for 10Gbps Ethernet. All the cables mentioned above do not have individually- shielded pairs as the picture here, including Cat 6a.
Cat 7	This standard specifies four individually-shielded pairs (STP) inside an overall shield. Designed for transmission at frequencies up to 600 MHz. It has better performance than Cat 6a.

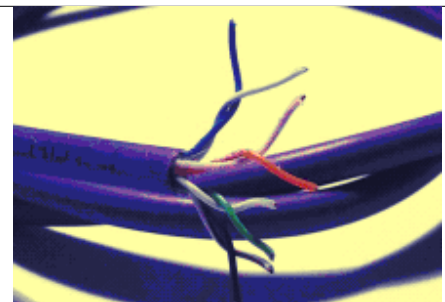

2.1.2. 10GBASE-R (Optical Fiber)

10GBASE-R is 10Gbps Ethernet connection that based on IEEE802.3ae. It uses fiber as transmission media with different specification of fiber, connector and transceiver. 10G SNR-CVT uses two standards, 10GBASE-LR and 10GBASE-SR.

10GBASE-SR

10GBASE-SR ("Short Range") uses 64B/66B encoding and 850 nm wavelength lasers. It is designed to support short distances over deployed multi-mode fiber cabling, it has a range of between 26 meters (85 ft) and 82 meters (270 ft) depending on cable type. It also supports 300 meters (980 ft) operation over new, 50 μ m 2000 MHz·km OM3 multi-mode fiber (MMF).

The transmitter can be implemented with a VCSEL (Vertical Cavity Surface Emitting Laser) which is low cost and low power. MMF has the advantage of having lower cost connectors than SMF (single-mode fiber) due to its wider core.

10GBASE-SR delivers the lowest cost, lowest power and smallest form factor optical modules.

10GBASE-LR

10GBASE-LR ("Long Range") is a Long Range Optical technology delivering serialized 10 gigabit Ethernet over a laser with 1310 nm wavelength connection on single-mode fiber via IEEE 802.3 Clause 49 64B-66B Physical Coding Sub layer (PCS) using a line rate of 10.3125.

Single-mode optical cabling is used to interconnect transceivers at a distance spaced at 10 kilometers (6.2 mi), but it can often reach distances of up to 25 kilometers (16 mi) with no data loss.

Fabry–Pйrot lasers are commonly used in 10GBASE-LR optical modules. Fabry–Pйrot lasers are more expensive than VCSELs (mentioned above) but their high power and focused beam allow efficient coupling into the small core of single mode fiber.

Fiber Specification

Fibers which support many propagation paths or transverse modes are called multi-mode fibers (MMF).

Fibers which can only support a single mode are called single-mode fibers (SMF). Multi-mode fibers generally have a larger core diameter, and are used for short-distance communication links and for applications where high power must be transmitted. Single-mode fibers are used for most communication links longer than 200 meters.

Fiber Buffer/Jacket Color	Meaning
Yellow	Single-mode optical fiber, long distance connection
Orange	Multi-mode optical fiber, short distance connection

2.2. Connection of UTP Cable and Optical fiber

2.2.1. 10GBASE-T (Copper Wire)

10GBASE-T uses the same RJ45 connector that is the same as original 100M/1000Mbps Ethernet network. Just plugging the RJ45 connector into the port of 10Gbps and it is ready to work. When connected properly, the Link/ACT LED located under the RJ45 Port will be on accordingly.

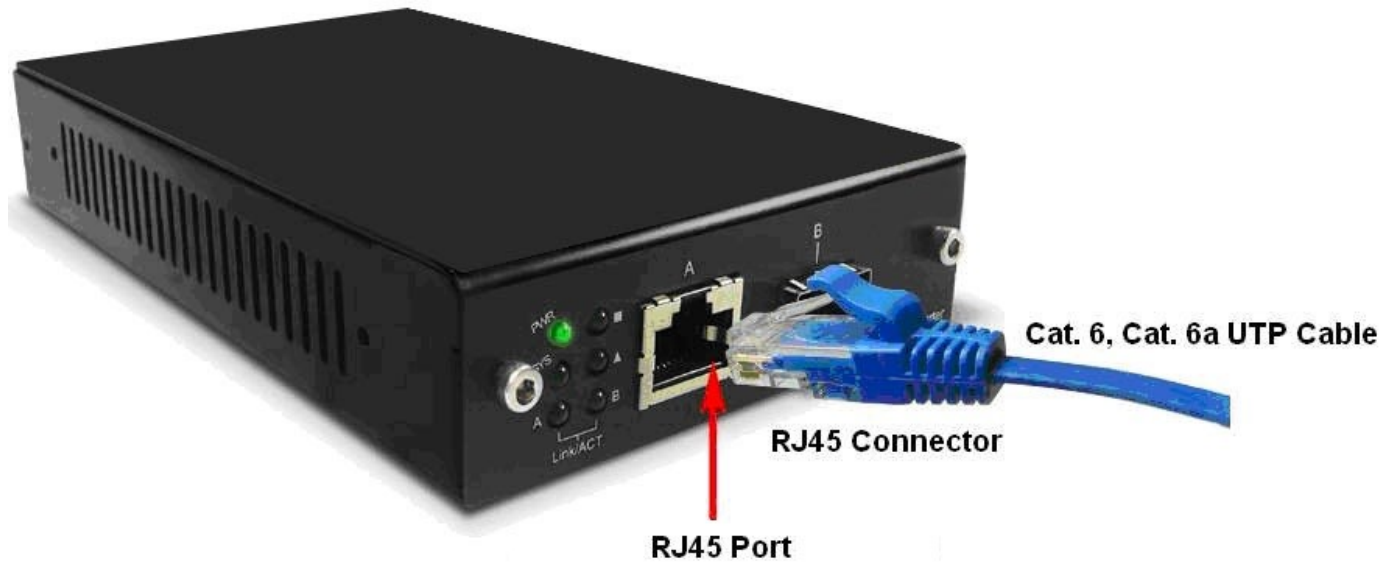

2.2.2. 10GBASE-R (Optical Fiber)

Please see the figure down below for connecting the optical fiber, transceiver, and 10G SNR-CVT's SFP+ Port.

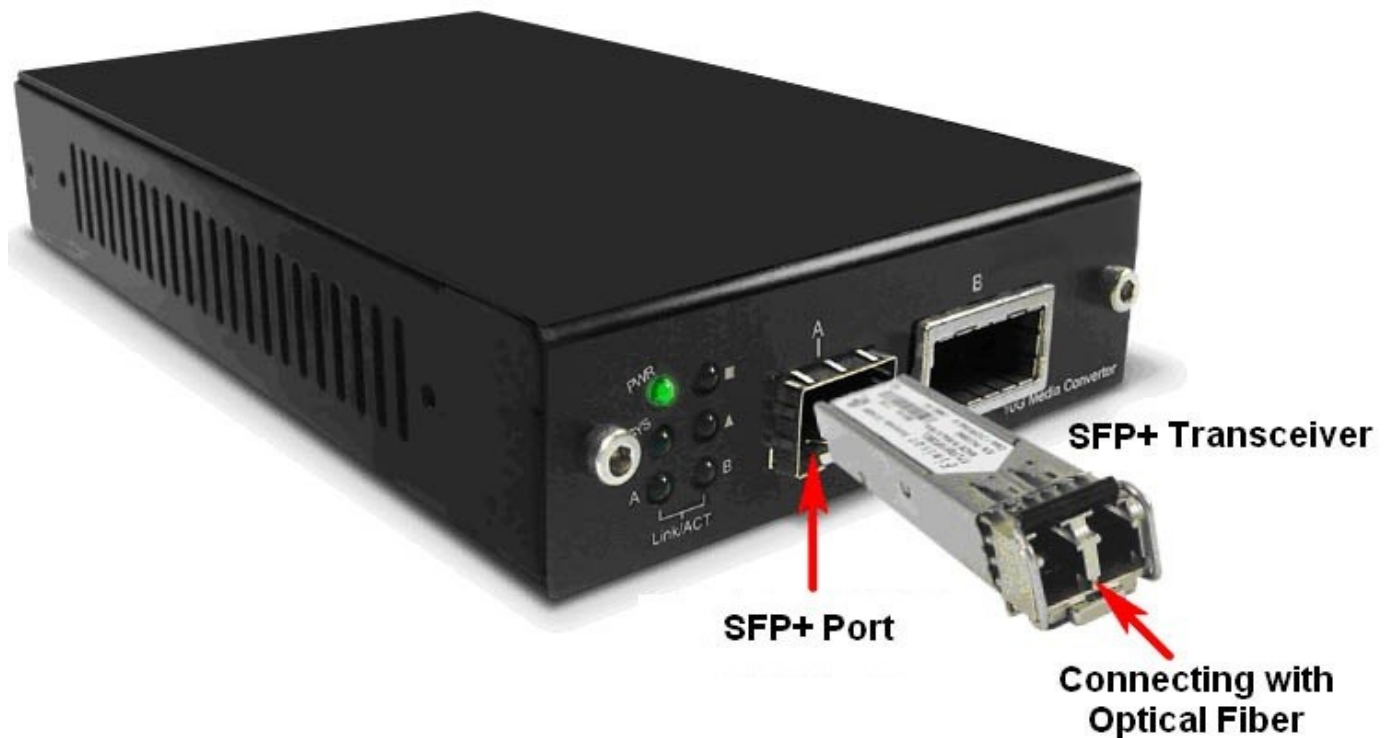

Optical Fiber

As mentioned above, there are Single-mode and Multi-mode optical fiber. Both of them can be used for 10G SNR-CVT series.

Fiber Connector

Optical fiber connector contains two ends of fibers and can attach to SFP+ transceivers. There are two ports for one SFP+ transceiver: one fiber is for receiving and one fiber is for transmitting. The picture here is called LC connector that can attach to SFP+ transceiver.



Transceiver (Connector)

SFP+/XFP Transceivers can be plugged into 10G SNR-CVT's SFP+/XFP Ports. SFP+/XFP Transceivers are active components that consume power from 10G SNR-CVT and are capable of converting signals between optical data flow and electronic data flow.

For different transmission purpose, the component inside SFP+ form factor can be 10BASE-LR or 10BASE-SR mode.



2.3. Applications Examples for Your Network

2.3.1. Application for University

10Gbps speed Ethernet connection may not be commonly seen in ordinary offices. However, network administrators may have Gigabit Ethernet in their control rooms already. Getting 10Gbps Ethernet connection from Internet Backbone and distributing it to different Gigabit Ethernet segment for different buildings or organizations is practical and more cost-effective. Figure down below is an example of a possible network structure for a university:

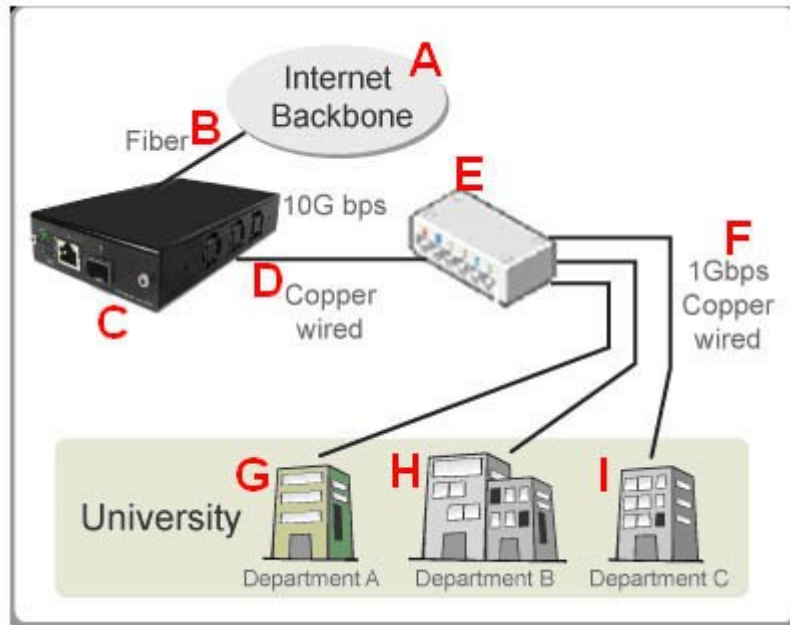

Descriptions	
A	Internet backbone from ISP.
B	The distance from the central office to the university might be long, and it is advised to construct the connection via single-mode optical fiber with 10BASE-LR mode, which can extend the distance beyond tens of kilometers.
C	10G SNR-CVT, which is located at the computer center of university.
D	After the conversions made by 10G SNR-CVT, expensive equipments for transmitting/receiving network data via optical fiber are not required anymore.
E	Full 10Gbps Ethernet switches may be exceeding your budget or not available. Some 1Gbps switches reserve a swappable slot for future upgrading. You can purchase a 10Gbps module with one 10Gbps port for these switches to serve the same purpose.
F	Several 1Gbps connections can be distributed by the switches mentioned above to different buildings inside the university by Cat 6a network cables (which can be extended to 100 meters).
G/H/I	General switches with 1Gbps or 100Mbps ports can be connected here for the end-users.

2.3.2. Application for Online Game Company

For ISPs or online game companies, 10G SNR-CVT series provide a more economical solution for control room cabling. ISP runs lots of customer's service such as e-mail servers, web servers or any co-located network services in the control rooms. These equipments may not have the interface for the connection of optical fibers. For online game company, administrators may have lots of online game servers that need high-speed connections to Internet backbone in the control rooms as well. .

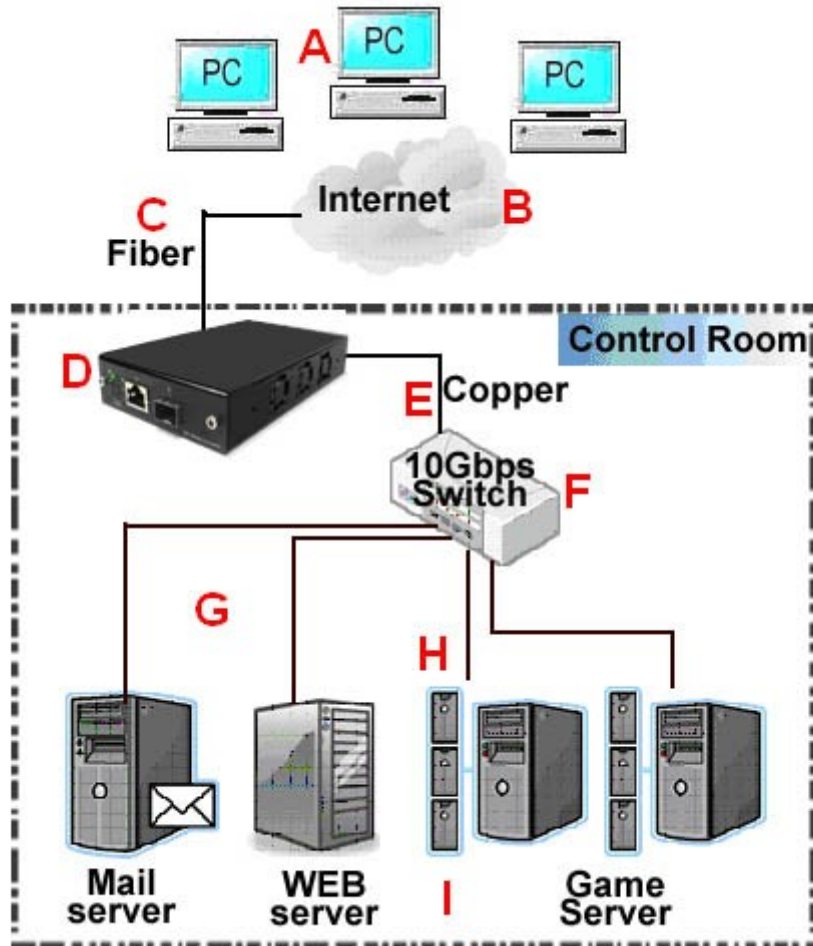

Descriptions	
A	Internet client users
B	Mass requests of the general public, coming from other ISPs through Internet.
C	The distance from other ISPs to the game company might be long, and it is advised to construct the connection via single-mode optical fiber with 10BASE-LR mode, which can extend the distance beyond tens of kilometers.
D	10G SNR-CVT, which is located at the control room of the game company.
E	After the conversions made by 10G SNR-CVT, expensive equipments for transmitting/receiving network data via optical fiber are not required anymore.
F	Depending on the network loading requirements, Ethernet Switch with full 10Gbps ports or partial 10Gbps/1Gbps ports should be configured for data flow distributions.
G	If that the bandwidth requirement of co-located mail servers for some companies is not heavy, you can connect them to 1Gbps port of 10Gbps switch as shown in the figure above.
H	If the bandwidth requirement of online game servers is heavy, you can connect them to 10Gbps port of 10Gbps switch as shown in the figure above.
I	Different kinds of server with different applications are located side by side by connections from 10Gbps Ethernet Switch via inexpensive Cat.6 cable.

2.3.3. Application for Home Users

The figure down below is an example of how the FTTX architectures may vary regarding to distances between the optical fiber and the end-users. Fiber to the x (FTTX) is a generic term for any network architecture that uses optical fiber to replace all or part of the usual copper local loop used for telecommunications. These four technologies are listed down below:

- Fiber to the node / neighborhood (FTTN) ➤ Fiber to the building (FTTB)
- Fiber to the curb (FTTC) / Fiber to the kerb ➤ Fiber to the home (FTTH)
- (FTTK)

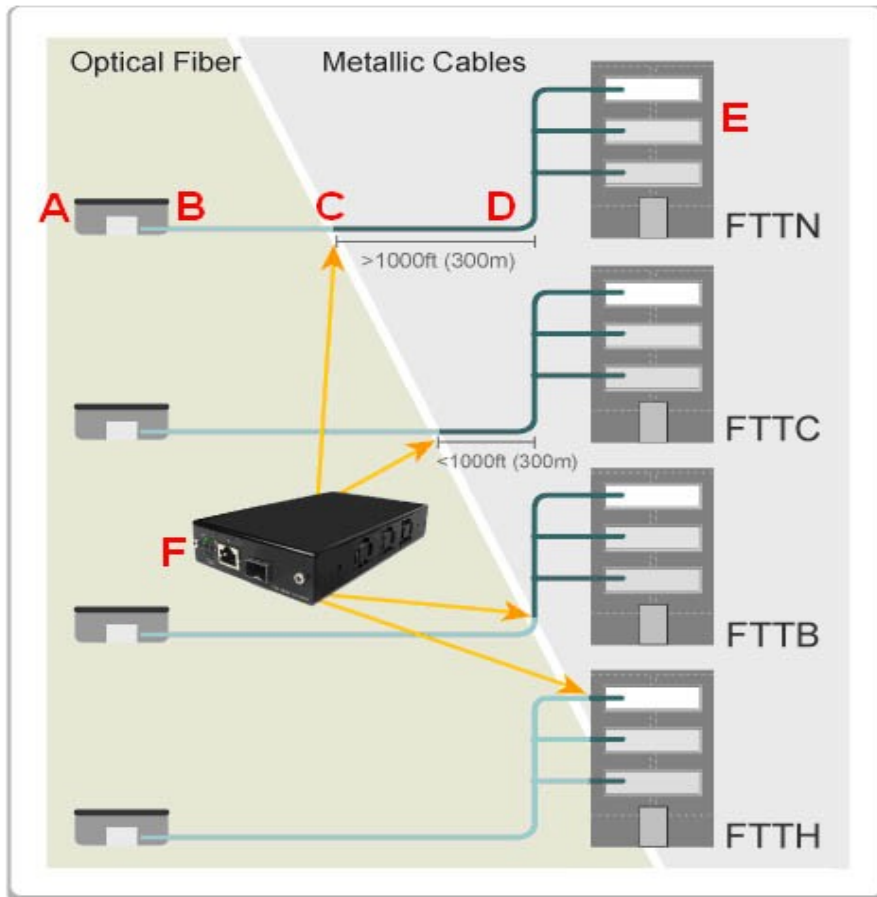

The building on the left is the central office. The building on the right is one of the buildings served by the central office. The white or gray blocks represent separate rooms or office spaces within the same building.

Descriptions	
A	ISP Central Office
B	Network connection via optical fiber
C	Installation of 10G SNR-CVT for media conversion
D	Network connection via copper wire. It can be Cat 6a cable (under 300 meters) or telephone line via xDSL (Technologies such as VDSL provide high speed, short-range link are used often in FTTx service)
E	Different rooms of homes or different compartments in the same building.
F	10G SNR-CVT can be located at any place that near or away from building, depending on the service to home users.

3. 10G SNR-CVT Management

You can configure 10G SNR-CVT's settings and view statistics generated while performing media converting with 10G SNR-CVT by:

- Connecting 10G SNR-CVT and PC to the same network via an RJ45 cable, and accessing 10G SNR-CVT's settings/statistics with **PC's web browser**.
- Connecting 10G SNR-CVT and PC via a 2.5mm Phone Jack to RS232 cable, and accessing 10G SNR-CVT's settings/statistics with **HyperTerminal Softwares**.

Please see the sections down below for more information regarding to 10G SNR-CVT management.

3.1. Managing 10G SNR-CVT with Management Webpage

10G SNR-CVT Series is embedded with a management webpage, and can be accessed by connecting 10G SNR-CVT Series' **Management Port** to the network which your PC is connected to via an RJ45 cable.

Before accessing to 10G SNR-CVT Series' configuration webpage with your PC's web browser, please set the network according 10G SNR-CVT Series' default IP Address (**192.168.1.8**). The figure down below is an example of network/PC settings for accessing 10G SNR-CVT Series management webpage.

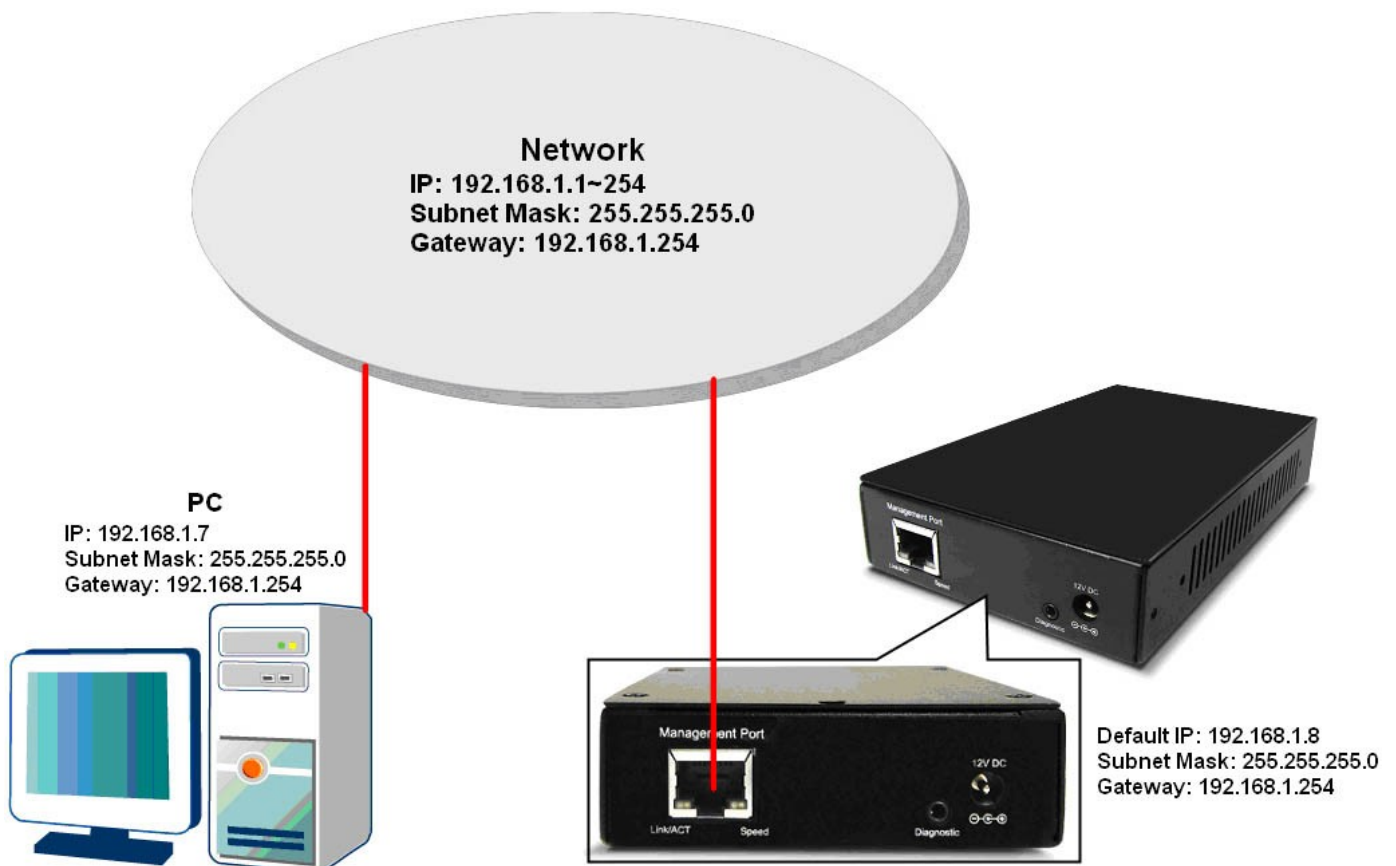

3.1.1. Accessing 10G SNR-CVT Management Webpage

To access 10G SNR-CVT Series' management webpage, please open your web browser, and type in 10G SNR-CVT Series' default IP address (**192.168.1.8**) in web browser's URL field as shown in the figure on the right side. **If you've changed 10G SNR-CVT Series' IP address, please input the IP address you've changed to instead.**

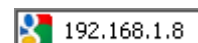

10G SNR-CVT Series' management webpage only supports Microsoft Internet Explorer ®, and 10G SNR-CVT Series' management webpage might not display correctly if you're using other web browser.

A window will pop up after you entering 10G SNR-CVT Series' IP address. Please enter the User Name and Password for 10G SNR-CVT Series' configuration webpage.



- **Default User Name: admin**
- **Default Password: admin***
*Please note that the User Name and Password are case-sensitive.

For safety issues, it is highly recommended that you should change the User name and Password when logging to 10G SNR-CVT Series' management webpage for the first time.

After inputting 10G SNR-CVT Series management webpage's User Name and Password, you should be able to see 10G SNR-CVT Series' management webpage displayed on your web browser as shown in the figure down below. The following sections will illustrate 10G SNR-CVT Series management webpage functions with **SNR-CVT-XFP**. Management webpage for other 10G SNR-CVT Series are quite the same and can be related.

3.1.2. 10G SNR-CVT Management Webpage – Overview

10G Media Converter

- ▼ System
 - System Information
- ▼ Management
 - IP Settings
 - User Settings
 - System Configuration
 - SNMP setting
- ▼ Counter
 - Device Counter
- ▶ Maintenance

Port Counter Statistics		
	Port A	Port B
Media Type	XFP	XFP
Link	Down	Down
Speed	n/a	n/a
Utilization(%)	0.00	0.00
Line Rate	0.00	0.00
Packet	0	0
Byte	0	0
Broadcast	0	0
Multicast	0	0
Unicast	0	0
Pause	0	0
Undersize	0	0
64 Bytes	0	0
65~127 Bytes	0	0
128~255 Bytes	0	0
256~511 Bytes	0	0

10G SNR-CVT Series Management Webpage Overview		
A	Port Status	<p>This field displays the port status of your 10G SNR-CVT series. You can view the media type of a specific port by moving the mouse to it.</p> <div style="display: flex; align-items: center;"> <ul style="list-style-type: none"> ➤ If 10G SNR-CVT's port is not connected, the Port Status icon will show as the figure on the left. ➤ If 10G SNR-CVT's port is connected, the Port Status icon will show as the figure on the left. </div> <p>Also, to view the counter report of a specific port, just click on the port.</p>
B	Setting Options	<p>The Setting Options contains options for 10G SNR-CVT Series' settings, information, and statistics, which can be divided into:</p> <ul style="list-style-type: none"> System: You can view system information here in this field. Management: This option allows you to make settings such as 10G SNR-CVT series' IP address, SNMP, or user accounts. Counter: You can view 10G SNR-CVT Series' counter reports with this option. Maintenance: This option allows you to save system settings, reboot 10G SNR-CVT Series, and reset all 10G SNR-CVT Series' settings to default value.
C	Model Name	<p>This field displays the model name of your 10G SNR-CVT series.</p>
D	Main Display Screen	<p>The Main Display Screen displays the system information, network tapping statistics, and detail configuration options.</p>

3.1.3. 10G SNR-CVT Management Webpage – System

A. System Information

System Information

S/N	OK7S81S001
MAC Address	00:22:A2:01:01:01
H/W Version	02
FPGA Version	v0.9b016
Firmware Version	v0.1b006
PortA SFP Factory	n/a
SFP Wavelength	n/a
PortB SFP Factory	n/a
SFP Wavelength	n/a

Management Port

IP Mode	Static
IP Address	192.168.1.8
Subnet Mask	255.255.255.0
Gateway	192.168.1.1

System Information displays 10G SNR-CVT Series' system information including:

System Information	
S/N	10G SNR-CVT Series' serial number.
MAC Address	10G SNR-CVT Series' MAC address.
FPGA Version	10G SNR-CVT Series' current FPGA (Field-Programmable Gate Array) version.
Firmware Version	10G SNR-CVT Series' current firmware version.
Port A SFP Factory	The manufacturer of the transceiver plugged in Port A.
Port B SFP Factory	The manufacturer of the transceiver plugged in Port B.
SFP Wavelength	The wavelength of Port A/B.
Management Port	
IP Mode	This field displays how 10G SNR-CVT Series acquires its IP address. <ul style="list-style-type: none"> • Static: 10G SNR-CVT Series' IP, subnet mask, and gateway addresses are assigned manually. • DHCP: 10G SNR-CVT Series' IP, subnet mask, and gateway addresses are assigned automatically by a DHCP server.
IP Address	10G SNR-CVT Series' IP address.
Subnet Mask	10G SNR-CVT Series' subnet mask.
Gateway	10G SNR-CVT Series' gateway address.

3.1.3. 10G SNR-CVT Management Webpage – Management

There are 3 options available for **Management**, which includes:

- **IP Configuration:** Allows you to set how 10G SNR-CVT will acquire its IP, subnet mask, and gateway addresses. Also, you could input these addresses manually here.
- **User Settings:** Allows you to change 10G SNR-CVT's configuration webpage User Name and Password.
- **System Configuration:** You can set **System Contact**, **System Location**, and **System Name** here.
- **SNMP Setting:** You can make SNMP (Simple Network Management Protocol) settings here.

Please see the sections for detail descriptions about settings available in **Management**:

A. IP Configuration

IP Configuration	
IP Mode	<input checked="" type="radio"/> Static <input type="radio"/> DHCP
IP Address	<input type="text" value="192.168.1.8"/>
Subnet Mask	<input type="text" value="255.255.255.0"/>
Gateway	<input type="text" value="192.168.1.1"/>
<input type="button" value="Apply"/>	

IP Configuration	
IP Mode	You can choose how 10G SNR-CVT acquires its IP, subnet mask, and gateway addresses. There are two modes available: <ul style="list-style-type: none"> • Static: You have to input 10G SNR-CVT's IP, subnet mask, and gateway addresses manually in the fields down below. • DHCP: 10G SNR-CVT acquires its IP, subnet mask, and gateway addresses automatically from network's DHCP server.
IP Address	You can input 10G SNR-CVT's IP address here in this field.
Subnet Mask	You can input 10G SNR-CVT's subnet mask here in this field.
Gateway	You can input 10G SNR-CVT's gateway address here in this field.
Apply	Apply the changes you've made here.

* Note: The default IP address for 10G SNR-CVT is 192.168.1.8.

B. User Settings

Administrator	
User Name	<input type="text"/>
New Password	<input type="text"/>
Confirm New Password	<input type="text"/>
<input type="button" value="Apply"/>	

Guest	
User Name	<input type="text"/>
New Password	<input type="text"/>
Confirm New Password	<input type="text"/>
<input type="button" value="Apply"/>	

For issues regarding to system security, 10G SNR-CVT has 2 different user security levels, which are:

- Administrator:** User with **Administrator** privilege can change 10G SNR-CVT system settings and view system information/statistics.
- Guest:** User with **Guest** privilege can only view system information/statistics.

User Settings for Administrator/Guest	
User Name	Input the user name here in this field.
New Password	Input the password here in this field. Please note that the password must contain at least 5 alphanumeric characters and is case sensitive.
Confirm New Password	Please input the password here again for confirmation.
Apply	Apply the changes you've made here.

C. System Configuration

System Configuration	
System Contact	<input type="text"/>
System Location	<input type="text"/>
System Name	<input type="text"/>
<input type="button" value="Apply"/>	

System Configuration	
System Contact	Input the contact information for 10G SNR-CVT here in this field.
System Location	Input the system's location for 10G SNR-CVT here in this field.

System Configuration	
System Name	Input the alias for 10G SNR-CVT here in this field.
Apply	Apply the changes you've made here.

D. SNMP Setting

SNMP Setting

Read Community	<input type="text"/>
Write Community	<input type="text"/>
<input type="button" value="Apply"/>	

SNMP Setting	
Read Community	Input the user name that has only READ privilege.
Write Community	Input the user name that has both WRITE and READ privileges.
Apply	Apply the changes you've made here.

3.1.4. 10G SNR-CVT Management Webpage – Counter

A. Device Counter

The **Counter Report** can display statistics reports of 10G SNR-CVT's **Port A/B**.

Port Counter Statistics

Auto Refresh

	Port A	Port B
Media Type	XFP	XFP
Link	Down	Down
Speed	n/a	n/a
Utilization	0	0
Line rate	0	0
Packet	0	0
Byte	0	0
Broadcast	0	0
Multicast	0	0
Unicast	0	0
Pause	0	0
Undersize	0	0
64 Bytes	0	0
65~127 Bytes	0	0
128~255 Bytes	0	0
256~511 Bytes	0	0
512~1023 Bytes	0	0
1024~1522 Bytes	0	0
Oversize	0	0
CRC Error	0	0
<input type="button" value="Refresh"/> <input type="button" value="Clear"/>		

Device Counter

Auto Refresh	Click the check box here allows the statistics table to refresh automatically.
Refresh	Refresh the configuration webpage and update the latest statistics.
Clear	Clear all statistics displayed in the table.

3.1.5. 10G SNR-CVT Management Webpage – Maintenance

Four options are available in the **Maintenance** configuration webpage: **Save Changes**, **System Reboot**, **Factory Defaults**, and **Logout**.

A. Save Changes

Save Changes

The device configuration will be saved to NV-RAM !

Save Changes	
Save	If you don't save the setting you've made via 10G SNR-CVT's configuration webpage, all settings will be erased after rebooting 10G SNR-CVT. Please click the " Save " button to save the settings to 10G SNR-CVT's NV-RAM.

B. Update F/W (Firmware)

Update Firmware

Choose Update file

Update F/W (Firmware)	
Browse...	Click the Browse... button to choose the firmware file you would like to upgrade. 10G SNR-CVT's firmware files are in the format of " *.bin ".
Send	Click this button to start upgrading 10G SNR-CVT's firmware.

C Update FPGA

Update FPGA

Choose Update file

Update FPGA	
Browse...	Click the Browse... button to choose the FPGA file you would like to upgrade. 10G SNR-CVT's FPGA files are in the format of " *.bin ".
Send	Click this button to start upgrading 10G SNR-CVT's FPGA.

D. System Reboot

System Reboot

System reboot

Warning! System will reboot! All unsaved data/settings will be lost after system reboot.

System Reboot	
Reboot	You can reboot 10G SNR-CVT by clicking the “ Reboot ” button. Please note that all unsaved settings will be lost after system reboot.

E. System Config

System Config	
System Config	Click System Config to save all 10G SNR-CVT’s current settings into a “*.cfg” file. You can upload this config file to 10G SNR-CVT with Config Upload function.

F. Config Upload

Config Upload

Choose System config

Config Upload	
Browse...	Click the Browse... button to choose the config file you would like to upload to 10G SNR-CVT. 10G SNR-CVT’s config files are in the format of “*.cfg”.
Send	Click this button to start uploading 10G SNR-CVT’s config file.

G. Factory Defaults

Restore Default Settings

Restore Default Settings

Warning! System will restore all settings to default! All unsaved data/setting will be lost after restore to default setting.

Factory Defaults	
Restore	You can set all 10G SNR-CVT’s settings to the default value by clicking the “ Restore ” button. Please note that all unsaved data/settings will be lost after restoring 10G SNR-CVT’s settings to default value.

3.2. Managing 10G SNR-CVT with HyperTerminal



10G SNR-CVT allows users to make system configurations and view test statistics/system information with **HyperTerminal**. To access 10G SNR-CVT via **HyperTerminal**, you have to connect 10G SNR-CVT's **Diagnostic Port** with **PC's RS-232 Port** via a 2.5mm Phone Jack to RS-232 cable as shown in the figure above.

The following sections will be using **SNR-CVT-XFP** as an example. Settings, installations, and HyperTerminal commands for other 10G SNR-CVT s are quite the same and can be related.

3.3.1. HyperTerminal Settings for 10G SNR-CVT

After connecting the **PC's serial port** to 10G SNR-CVT's **Console Port** via a **2.5mm Phone Jack to RS-232 cable**, please start the **HyperTerminal** software installed on your PC and establish connection according to the steps listed down below.

Establishing Connection with 10G SNR-CVT



1. Input a name for this connection, such as 10G SNR-CVT, and also select an icon for this connection. Click “**OK**” to continue.



2. Select the COM port of PC for this connection. Click “**OK**” to continue.

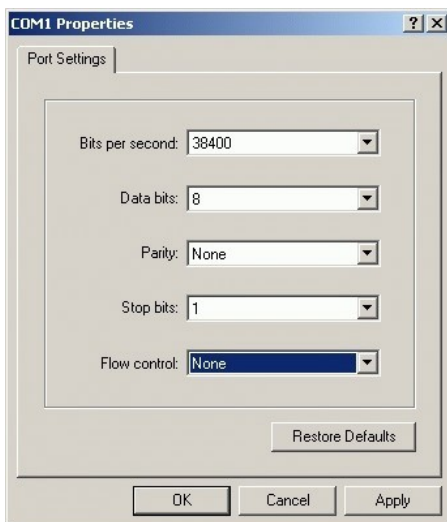

3. Set the COM port parameters according to the settings listed down below:

- **Bits per second: 38400**
- **Data bits: 8**
- **Parity: None**
- **Stop bits: 1**
- **Flow control: None**

Click “**OK**” to continue.

Establishing Connection with 10G SNR-CVT

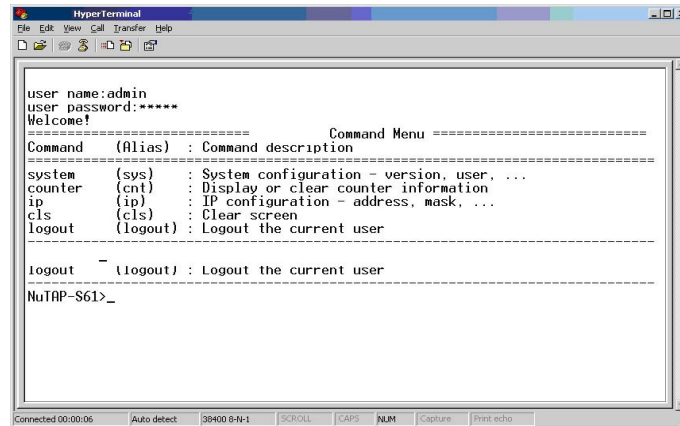

```
HyperTerminal
File Edit View Call Transfer Help
[Icons]
user name:admin
user password:*****
Welcome!
===== Command Menu =====
Command (Alias) : Command description
-----
system (sys) : System configuration - version, user, ...
counter (cnt) : Display or clear counter information
ip (ip) : IP configuration - address, mask, ...
cls (cls) : Clear screen
logout (logout) : Logout the current user
-----
logout (logout) : Logout the current user
-----
NuTAP-S61>_
```

Click the “Enter” key on your keyboard to start setting 10G SNR-CVT via HyperTerminal. To log in, please type 10G SNR-CVT’s user name and password:

- **Default User Name: admin**
- **Default Password: admin (Both the User Name and Password are case-sensitive.)**

If you change 10G SNR-CVT’s user name and password with 10G SNR-CVT’s configuration webpage, please log in with the new user name and password here.

3.3.2. 10G SNR-CVT HyperTerminal Commands

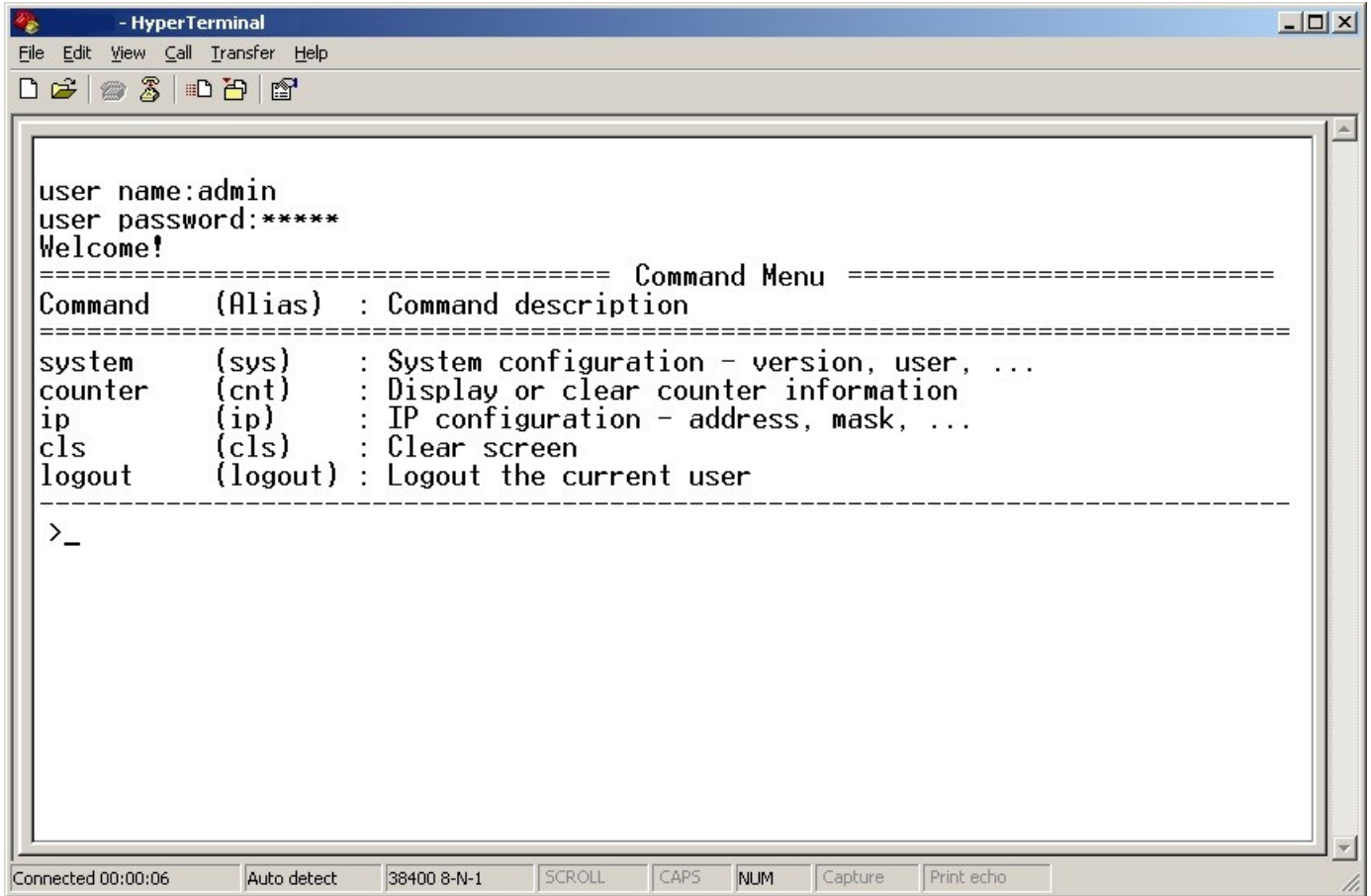

After logging in 10G SNR-CVT via HyperTerminal, a **10G SNR-CVT Command Menu** will be displayed, showing 10G SNR-CVT's HyperTerminal commands. Please see the table down below for brief descriptions of 10G SNR-CVT commands:

Command	Alias	Command Description
system	sys	The system command allows you to view 10G SNR-CVT's system information, make system configurations, and upgrade 10G SNR-CVT's firmware/FPGA.
counter	cnt	The counter command allows you to view 10G SNR-CVT's counter information.
ip	ip	The ip command allows you to view 10G SNR-CVT's current IP settings or configure these settings.
cls	cls	The cls command allows you to clear HyperTerminal screen.
logout	logout	The logout command allows you to log out. For security issues, it is recommended that you should log out if you're not using the HyperTerminal anymore.

Please see sections down below for more detailed information regarding to 10G SNR-CVT's command.

A. 10G SNR-CVT HyperTerminal Command – system

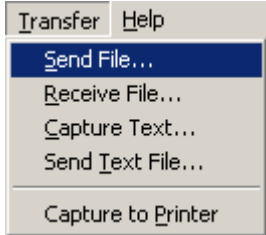
Command Descriptions – system			
system	show	The system show allows you to view 10G SNR-CVT's PCB/firmware/FPGA versions, as well as hardware temperature.	
	user	show	The system user show command allows you to view the current users and their passwords.
		admin	The system user admin [name password] <name password> command allows you to change the user name and its password of the user with administrator privilege. For example, if you type in system user admin name test123 and press enter, a user named test123 with administrator privilege will be created.
		guest	The system user guest [name password] <name password> command allows you to change the user name and its password of the user with guest privilege. For example, if you type in system user guest name test123 and press enter, a user named test123 with guest privilege will be created.
	devname	show	The system devname show command allows you to view the device name assigned to 10G SNR-CVT.
		set	The system devname set [device name] command allows you to view the device name assigned to 10G SNR-CVT.
	snmp	show	The system snmp show command will show the current SNMP (Simple Network Management Protocol) settings.
		writcommunity	The system snmp writcommunity <parameter> allows you to set the community with write privilege. The <parameter> can be public , private , or user names .
		readcommunity	The system snmp readcommunity <parameter> allows you to set the community with read privilege. The <parameter> can be public , private , or user names .
	save	The system save command allows you to save the current settings to 10G SNR-CVT's NV-RAM. Please note that all unsaved settings will be lost after system reboot.	
	update	<p>firmware/FPGA</p> <p>The system update [firmware/FPGA] commands allow you to upgrade 10G SNR-CVT's firmware/FPGA. The following descriptions are for upgrading SNR-CVT-XFP's firmware. However, procedures for upgrading 10G SNR-CVT's FPGA are quite the same and can be related.</p> <ol style="list-style-type: none"> 1. Type in "system update firmware" and click enter. Press Y to proceed and start upgrading firmware, or press N to cancel. <pre style="text-align: center;">>sys update firmware Do you want to update firmware? Y/N_</pre> <ol style="list-style-type: none"> 2. Press Transfer on HyperTerminal's menu bar and choose "Send File". 	

Command Descriptions – system

system (Contd.)

update (Contd.)

firmware/FPGA (Contd.)

3. A **Send File** window will pop up. Please set the **Protocol** to **Xmodem**, and click the **Browse** button.

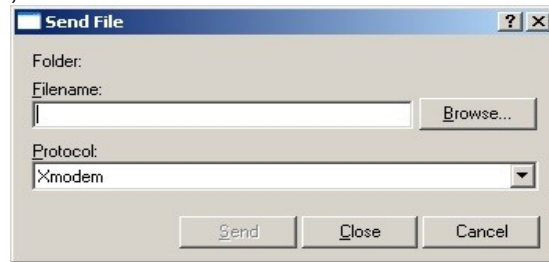

4. Choose the firmware you would like to upgrade to and click **Open**.

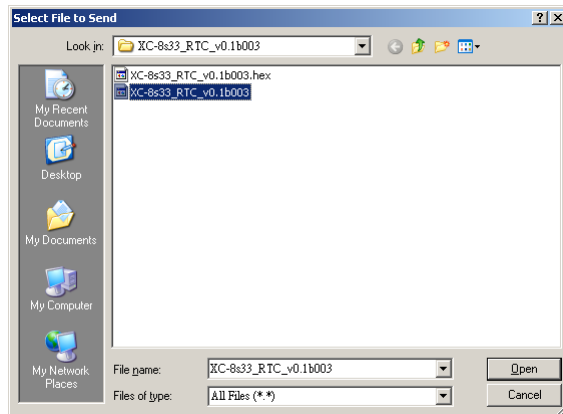

5. Click the **Send** button to start sending firmware.

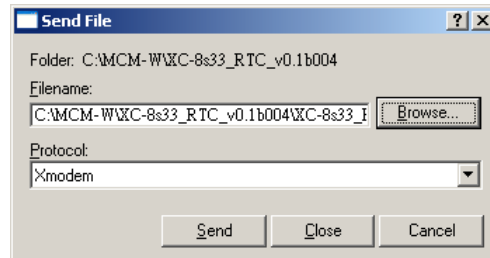

6. System is sending firmware to 10G SNR-CVT.

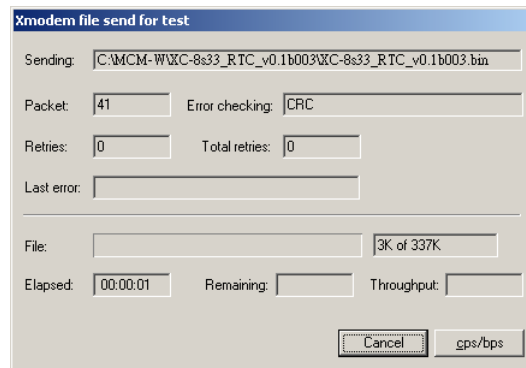

7. 10G SNR-CVT will reboot when finishing upgrading its firmware.

reset The **system reset** command allows you to reset all 10G SNR-CVT's settings back to the default values.

reboot The **system reboot** command allows you to reboot 10G SNR-CVT. Please note that all unsaved settings will be lost after rebooting.

B. 10G SNR-CVT HyperTerminal Command – counter

Command Descriptions – counter		
counter	show	<p>The counter show command allows you to view all 10G SNR-CVT's counter report.</p> <pre> Console Program Rev. 0.1 ----- Counter Port XFP XFP Link Status 10G 10G ----- Packet 0 Byte 0 Broadcast 0 Multicast 0 Unicast 0 Pause 0 Size:Under Size 0 Size:64 bytes 0 ----- <C>:Clear;<S>:Stop/Start Screen;<P>:Select Page 1/2;<Esc>:Exit ➤ C: Press C to clear all counters. ➤ S: Press S to stop/start refreshing counters. ➤ P: Press P to switch pages. 10G SNR-CVT's counter report has 2 pages. ➤ Esc: Press the Esc key to exit 10G SNR-CVT's counter report. </pre>
	clear	<p>0 Clear all counter reports of 10G SNR-CVT's Port A.</p> <p>1 Clear all counter reports of 10G SNR-CVT's Port B.</p> <p>all Clear all counter reports of 10G SNR-CVT's Port A and Port B.</p>
refreshtime	show	The refreshtime show command allows you to view the refresh time for the report.
	set	The refreshtime set command allows you to set the refresh time (in seconds) for the report.

C. 10G SNR-CVT HyperTerminal Command – ip

Command Descriptions – ip			
ip	show	The ip show command allows you to view information of 10G SNR-CVT's IP configuration.	
	status	The ip status command allows you to view information of 10G SNR-CVT's IP status.	
	mode	dhcp	The ip mode dhcp command allows you to set 10G SNR-CVT's IP acquiring mode to DHCP, allowing 10G SNR-CVT to acquire IP automatically from DHCP server.
		static	The ip mode static command allows you to set 10G SNR-CVT's IP acquiring mode to Static, allowing you to set IP/Subnet Mask/Gateway IP manually.
	address*	The ip address <IP Address> command allows you to set 10G SNR-CVT's IP address. For example, to set 10G SNR-CVT's IP address to 192.168.1.20, please input the command " ip address 192.168.1.20 ".	
	mask*	The ip mask <Subnet Mask Address> command allows you to set 10G SNR-CVT's subnet mask address. For example, to set 10G SNR-CVT's subnet mask address to 255.255.255.0, please input the command " ip mask 255.255.255.0 ".	
	gateway*	The ip gateway <Gateway Address> command allows you to set 10G SNR-CVT's gateway address. For example, to set 10G SNR-CVT's subnet gateway address to 192.168.1.254, please input the command " ip gateway 192.168.1.254 ".	

*10G SNR-CVT's default IP address/subnet mask/default gateway are 192.168.1.8/255.255.255.0/192.168.1.1

D. 10G SNR-CVT HyperTerminal Command – cls

Command Descriptions – cls	
cls	The cls command allows you to clear HyperTerminal screen.

E. 10G SNR-CVT HyperTerminal Command – logout

Command Descriptions – logout	
logout	The logout command allows you to log out of 10G SNR-CVT's HyperTerminal configuration session.

4. 10G SNR-CVT General Specifications

System Control	
System Control	<ul style="list-style-type: none"> ➤ Transceiver Power ON/OFF ➤ Selectable Auto/Force Media Type ➤ Link Connection Mode: Slave/Segment ➤ System Upgrade (F/W, FPGA)
Device Status Report	
Status Report	<ul style="list-style-type: none"> ➤ Information ➤ Link Status ➤ Temperature Detection ➤ Module Detection ➤ Fiber Module Detection ➤ Transceiver overloading
MIB Counter Report *	
Counter Report	<ul style="list-style-type: none"> ➤ Packet ➤ Broadcast packet ➤ Length: 64 Bytes ➤ Length: 128-255 Bytes ➤ Length: 512-1023 Bytes ➤ Unicast packet ➤ CRC Error ➤ Under size packet ➤ Byte ➤ Pause Frame ➤ Length: 65-127 Bytes ➤ Length: 256-511 Bytes ➤ Length: 1024-1518 Bytes ➤ Multicast packet ➤ IP Checksum Error * ➤ Over size packet
Hardware	
Temperature	<ul style="list-style-type: none"> ➤ Operating: 0°C ~ 40°C (32°F ~ 104°F) ➤ Storage: 0°C ~ 50°C (32°F ~ 122°F)
Humidity (non-condensing)	<ul style="list-style-type: none"> ➤ Operating: 0% ~ 85% RH ➤ Storage: 0% ~ 85% RH
Dimension	147 mm x 89 mm x 28 mm